

**kablo kanalları**  
**cablc trays**

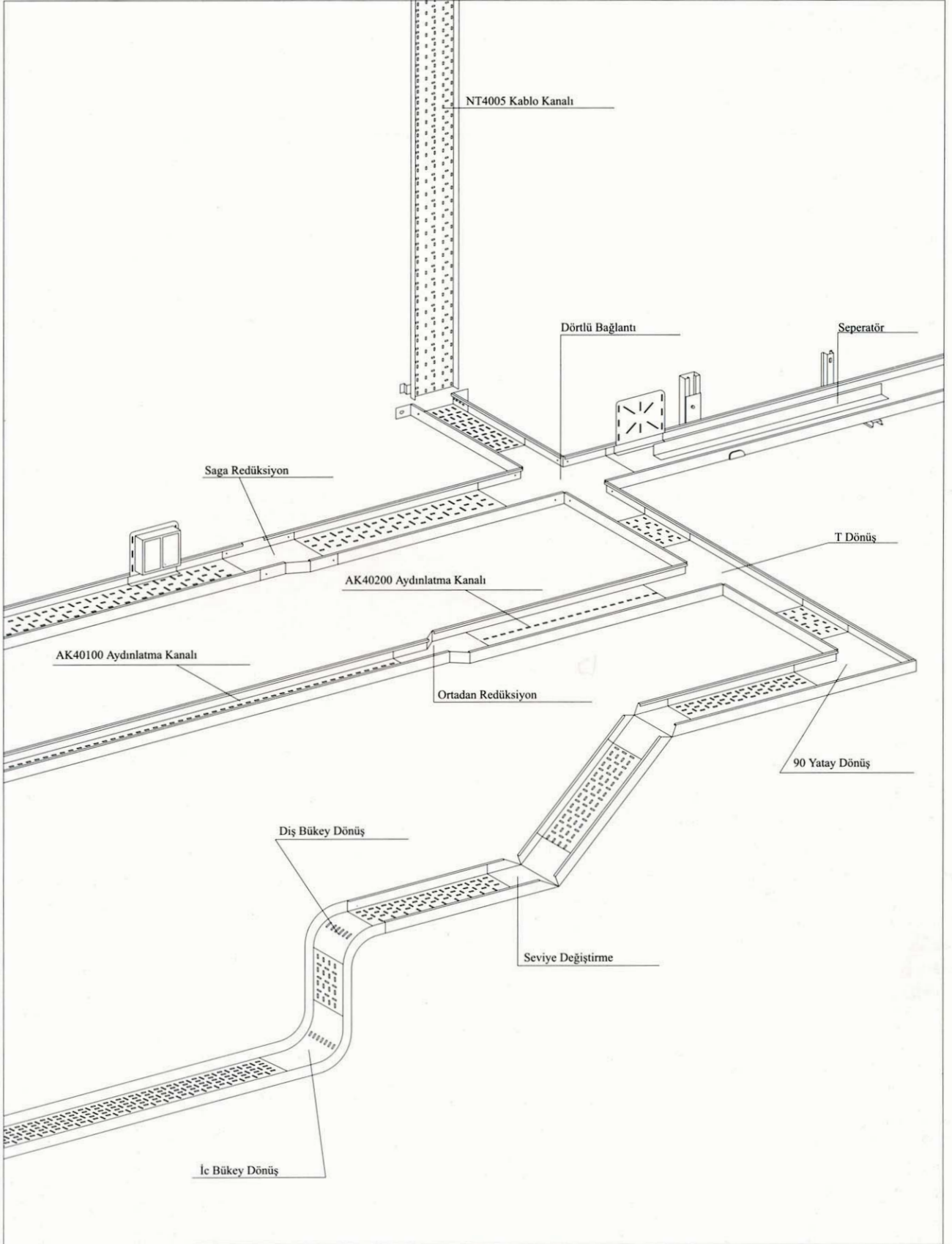

## İÇİNDEKİLER / CONTENTS

<b>PERFORE KABLO KANALLARI / PERFORATED CABLE TRAYS</b>	<b>1</b>
<b>BİRLEŞTİRME ELEMANLARI / JUNCTION ELEMENTS</b>	
90 Yatay Dönüş / 90 Bend	2
T Dönüş / T-Junction	2
Sola Redüksiyon / Left reduction	3
Sağa Redüksiyon / Right Reduction	3
Ortadan redüksiyon / Mid- Reduction	4
Dörtlü Bağlantı / 4 Joint	4
Dış Bükey Dönüş / Convex Turn	5
İç Bükey Dönüş / Concave Turn	5
Seviye Değiştirme / Level Changer	6
Sonlandırma Kapağı / End Cover	6
<b>KABLO MERDİVENLERİ / CABLE LADDERS</b>	<b>7</b>
90 Yatay Dönüş / 90 Bend	7
T Dönüş / T-Junction	8
Dörtlü Bağlantı / 4 Joint	8
İç Bükey Dönüş / Concave Turn	9
Dış Bükey Dönüş / Convex Turn	9
<b>AĞIR TİP KABLO KANALLARI / HEAVY DUTY TYPE TRAYS</b>	<b>10</b>
EK ELEMANI Add-in Element	11
Seperatör / Seperator	11
Bağlantı Kutu Pleyti / Joint Box Plate	11
Çiftli Soket ve Bağlantı Kutu Pleyti / Two Sockets & Joint Box Plate	11
<b>ASKI SİSTEMLERİ VE DUVAR KONSOLLARI / PENDANT SYSTEMS &amp; CONSOLES</b>	<b>12</b>
Dahili Dirsek Kolu / Internal Cantilever Arm (D17)	12
Tavan Askı Aksesuarı / Ceiling Pendant Accessory (D73)	12
Uzatma Profili / Lengting Profile (D33)	12
Açı Braketi Angle Bracket(D8)	12
Dirsek Kolu / Cantilever Arm (H50)	13
Dirsek Kolu / Cantilever Arm (H70)	13
Askı Ucu / Pendant End (A21)	13
Destek Braketi / Support Bracket (A1940)	13
Askı Barası / Pendant Bar (A1)	14
Montaj Rayı / Mounting Rail (T40)	14
Tavan Bağlantısı / Ceiling Attachment (T31)	14
Askı Rayı / Pendant Rail (T32)	14
Dik Parça / Vertical Piece (T2)	15
M10 Tij / Teege (T76)	15
Askı Braketi / Pendant Bracket (T81)	15
Destek Braketi / Support Bracket (T20)	15
Askı Desteği / Pendant Support (A80)	16
<b>YÜK DİYAGRAMLARI / LOAD DIAGRAMS</b>	<b>16</b>
<b>VİDA SOMUN SETLERİ / NUT BOLT SETS</b>	<b>17</b>





## PERFORE KABLO KANALLARI / PERFORATED CABLE TRAYS

### NORMAL TİP KABLO KANALLARI / NORMAL TYPE CABLE TRAYS

Sipariş Kodu / Order No	H mm	A mm	t mm
NT 4005	40	50	1
NT 4010	40	100	1
NT 4020	40	200	1
NT 4030	40	300	1.2
NT 4040	40	400	1.2
NT 4050	40	500	1.5
NT 4060	40	600	1.5
NT 6005	60	50	1
NT 6010	60	100	1
NT 6020	60	200	1.2
NT 6030	60	300	1.5
NT 6040	60	400	1.5
NT 6050	60	500	1.5
NT 6060	60	600	1.5

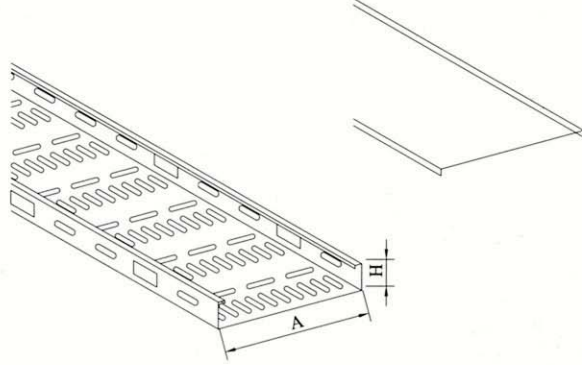

Kanal Kapağı / Tray Cover
NT 4005 K
NT 4010 K
NT 4020 K
NT 4030 K
NT 4040 K
NT 4050 K
NT 4060 K
NT 6005 K
NT 6010 K
NT 6020 K
NT 6030 K
NT 6040 K
NT 6050 K
NT 6060 K

Kablo kanalı NT perfore edilmiş yan duvarlardan kablo çıkışı için contalı dikdörtgen kanallar açılmış pregalvaniz veya beyaz boyalı uzunluk 2 metre olarak imal edilir. Diğer ölçüler isteğe göre imal edilebilir.  
Perforated pregalvanized, painted white with a length of 2 m. Other dimensions can be produced on demand

### AĞIR HİZMET TİP KABLO KANALLARI / HEAVY DUTY TYPE CABLE TRAYS

Sipariş Kodu / Order No	H mm	A mm	t mm
AG 6010	60	100	1.5
AG 6020	60	200	1.5
AG 6030	60	300	1.5
AG 6040	60	400	2
AG 6050	60	500	2
AG 6060	60	600	2
AG 10010	100	100	2
AG 10020	100	200	2
AG 10030	100	300	2
AG 10040	100	400	2
AG 10050	100	500	2
AG 10060	100	600	2

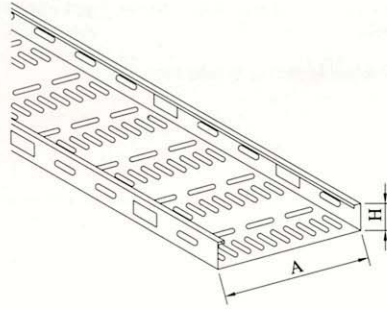

Kanal Kapağı / Tray Cover
AG 6010 K
AG 6020 K
AG 6030 K
AG 6040 K
AG 6050 K
AG 6060 K
AG 10010 K
AG 10020 K
AG 10030 K
AG 10040 K
AG 10050 K
AG 10060 K

### GEMİCİ TİP KABLO KANALLARI / SHIP TYPE CABLE TRAYS

Sipariş Kodu / Order No	A mm	t mm
GT 50	50	1
GT 100	100	1
GT 150	150	1
GT 200	200	1.2
GT 250	250	1.2
GT 300	300	1.2
GT 400	400	1.5

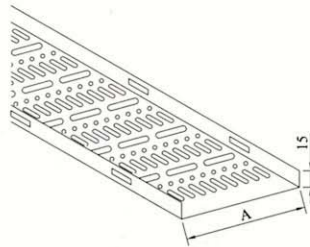

Kanal Kapağı / Tray Cover
GT 50 K
GT 100 K
GT 150 K
GT 200 K
GT 250 K
GT 300 K
GT 400 K

### GEMİCİ TİP KABLO KANALLARI / SHIP TYPE CABLE TRAYS

Sipariş Kodu / Order No	H mm	A mm	t mm
AK 2240	22	40	1.5
AK 4070	40	70	1
AK 40100	40	100	1
AK 40200	40	200	1

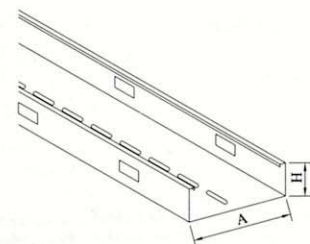

Kanal Kapağı / Tray Cover
AK 2240 K
AK 4070 K
AK 40100 K
AK 40200 K

Aydınlatma Kanalları AK pregalvaniz veya beyaz boyalı uzunluk 2500 mm olarak imal edilir.  
Lighting Trunkings pregalvanized, painted white with a length of 2500 mm

## BİRLEŞTİRME ELEMANLARI / JOINT ELEMENTS

### 90 YATAY DÖNÜŞ / HORIZONTAL BEND (YD)

Sipariş Kodu / Order No	H mm	A mm
GT 50 YD	15	50
GT 100 YD	15	100
GT 150 YD	15	150
GT 200 YD	15	200
GT 250 YD	15	250
GT 300 YD	15	300
GT 400 YD	15	400
NT 4005 YD	40	50
AK 4070 YD	40	70
NT 4010 / AK 40100 YD	40	100
NT 4020 / AK 40200 YD	40	200
NT 4030 YD	40	300
NT 4040 YD	40	400
NT 4050 YD	40	500
NT 4060 YD	40	600
NT 6005 YD	60	50
NT 6010 / AG 6010 YD	60	100
NT 6020 / AG 6020 YD	60	200
NT 6030 / AG 6030 YD	60	300
NT 6040 / AG 6040 YD	60	400
NT 6050 / AG 6050 YD	60	500
NT 6060 / AG 6060 YD	60	600
AG 10010 YD	100	100
AG 10020 YD	100	200
AG 10030YD	100	300
AG 10040 YD	100	400
AG 10050 YD	100	500
AG 10060 YD	100	600

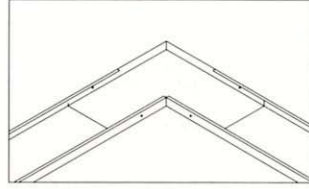
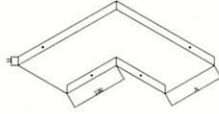

90° yatay açılı birleştirme amacıyla kullanılır.  
Uygun kanal içerisine sokularak birleştirilir.

*Can be joined by putting suitable tray*

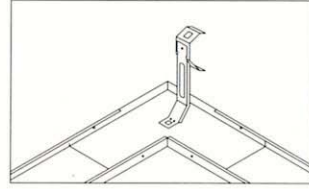

Gerekirse 90° Yatay Dönüş elemanı M5 vida somun kullanarak birleştirilir.  
A21 ve D73 askı elemanları tabandan delik delme sureti ile 90° Yatay Dönüş elemanı askılamakta kullanılabilir.

*It can be joint with M5 bolt whenever necessary*

Yatay Dönüş Kanal Kapağı / Horizontal Bend Tray cover
GT 50 YD K
GT 100 YD K
GT 150 YD K
GT 200 YD K
GT 250 YD K
GT 300 YD K
GT 400 YD K
NT 4005 YD K
AK 4070 YD K
NT 4010 / AK 40100 YD K
NT 4020 / AK 40200 YD K
NT 4030 YD K
NT 4040 YD K
NT 4050 YD K
NT 4060 YD K
NT 6005 YD K
NT 6010 / AG 6010 YD K
NT 6020 / AG 6020 YD K
NT 6030 / AG 6030 YD K
NT 6040 / AG 6040 YD K
NT 6050 / AG 6050 YD K
NT 6060 / AG 6060 YD K
AG 10010 YD K
AG 10020 YD K
AG 10030YD K
AG 10040 YD K
AG 10050 YD K
AG 10060 YD K

### T DÖNÜŞ / T JOINT (TD)

Sipariş Kodu / Order No	H mm	A mm
GT 50 TD	15	50
GT 100 TD	15	100
GT 150 TD	15	150
GT 200 TD	15	200
GT 250 TD	15	250
GT 300 TD	15	300
GT 400 TD	15	400
NT 4005 TD	40	50
AK 4070 TD	40	70
NT 4010 / AK 40100 TD	40	100
NT 4020 / AK 40200 TD	40	200
NT 4030 TD	40	300
NT 4040 TD	40	400
NT 4050 TD	40	500
NT 4060 TD	40	600
NT 6005 TD	60	50
NT 6010 / AG 6010 TD	60	100
NT 6020 / AG 6020 TD	60	200
NT 6030 / AG 6030 TD	60	300
NT 6040 / AG 6040 TD	60	400
NT 6050 / AG 6050 TD	60	500
NT 6060 / AG 6060 TD	60	600
AG 10010 TD	100	100
AG 10020 TD	100	200
AG 10030TD	100	300
AG 10040 TD	100	400
AG 10050 TD	100	500
AG 10060 TD	100	600

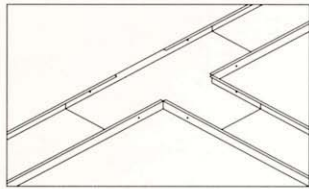
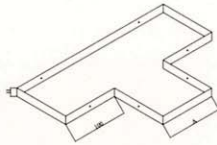

90° yatay T kavşak birleştirme amacıyla kullanılır.

*Can be joined by putting suitable tray.*

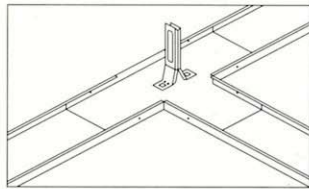

Gerekirse T Dönüş elemanı M5 vida somun kullanarak birleştirilir.  
A21 ve D73 askı elemanları tabandan delik delme sureti ile T elemanı askılamakta kullanılabilir.

*It can be joint with M5 bolt whenever necessary*

T Dönüş Kanal Kapağı / T Joint Tray Cover
GT 50 TD K
GT 100 TD K
GT 150 TD K
GT 200 TD K
GT 250 TD K
GT 300 TD K
GT 400 TD K
NT 4005 TD K
AK 4070 TD K
NT 4010 / AK 40100 TD K
NT 4020 / AK 40200 TD K
NT 4030 TD K
NT 4040 TD K
NT 4050 TD K
NT 4060 TD K
NT 6005 TD K
NT 6010 / AG 6010 TD K
NT 6020 / AG 6020 TD K
NT 6030 / AG 6030 TD K
NT 6040 / AG 6040 TD K
NT 6050 / AG 6050 TD K
NT 6060 / AG 6060 TD K
AG 10010 TD K
AG 10020 TD K
AG 10030TD K
AG 10040 TD K
AG 10050 TD K
AG 10060 TD K

Standart imalat malzemesi pregalvaniz sactır. / Standard production material is pregalvanized sheet.  
Boyalı ürünler için sipariş sonuna (B) harfi ekleyiniz. / For painted orders please add 'B' to the order no

\* / (ve) anlamında kullanılmıştır.

## BİRLEŞTİRME ELEMANLARI / JOINT ELEMENTS

### SOLA REDÜKSİYON / LEFT REDUCTION (SR)

Sipariş Kodu / Order No	H mm	A mm	B mm
GT 200 SR	15	200	100
GT 300 SR 10	15	300	100
GT 300 SR 20	15	300	200
GT 400 SR 10	15	400	100
GT 400 SR 20	15	400	200
GT 400 SR 30	15	400	300
NT 4020 / AK 40200 SR	40	200	100
NT 4030 SR 10	40	300	100
NT 4030 SR 20	40	300	200
NT 4040 SR 10	40	400	100
NT 4040 SR 20	40	400	200
NT 4040 SR 30	40	400	300
NT 6020 / AG 6020 SR	60	200	100
NT 6030 / AG 6030 SR 10	60	300	100
NT 6030 / AG 6030 SR 20	60	300	200
NT 6040 / AG 6040 SR 10	60	400	100
NT 6040 / AG 6040 SR 20	60	400	200
NT 6040 / AG 6040 SR 30	60	400	300
AG 10020 SR	100	200	100
AG 10030 SR 10	100	300	100
AG 10030 SR 20	100	300	200
AG 10040 SR 10	100	400	100
AG 10040 SR 20	100	400	200
AG 10040 SR 30	100	400	300

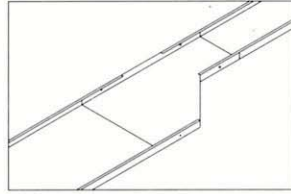
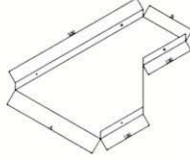

Değişik genişliğe sahip kablo kanalları arasında geçiş sağlar.

Supplies passing through various cable trays

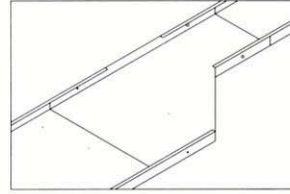

Gerekirse Sola Redüksiyon elemanı M5 vida somun kullanarak birleştirilir.

It can be joint with M5 bolt whenever necessary

Sola Redüksiyon Kanal Kapağı / Tray cover
GT 200 SR K
GT 300 SR 10 K
GT 300 SR 20 K
GT 400 SR 10 K
GT 400 SR 20 K
GT 400 SR 30 K
NT 4020 / AK 40200 SR K
NT 4030 SR 10 K
NT 4030 SR 20 K
NT 4040 SR 10 K
NT 4040 SR 20 K
NT 4040 SR 30 K
NT 6020 / AG 6020 SR K
NT 6030 / AG 6030 SR 10 K
NT 6030 / AG 6030 SR 20 K
NT 6040 / AG 6040 SR 10 K
NT 6040 / AG 6040 SR 20 K
NT 6040 / AG 6040 SR 30 K
AG 10020 SR K
AG 10030 SR 10 K
AG 10030 SR 20 K
AG 10040 SR 10 K
AG 10040 SR 20 K
AG 10040 SR 30 K

### SAĞA REDÜKSİYON / RIGTH REDUCTION (RR)

Sipariş Kodu / Order No	H mm	A mm	B mm
GT 200 RR	15	200	100
GT 300 RR 10	15	300	100
GT 300 RR 20	15	300	200
GT 400 RR 10	15	400	100
GT 400 RR 20	15	400	200
GT 400 RR 30	15	400	300
NT 4020 / AK 40200 RR	40	200	100
NT 4030 RR 10	40	300	100
NT 4030 RR 20	40	300	200
NT 4040 RR 10	40	400	100
NT 4040 RR 20	40	400	200
NT 4040 RR 30	40	400	300
NT 6020 / AG 6020 RR	60	200	100
NT 6030 / AG 6030 RR 10	60	300	100
NT 6030 / AG 6030 RR 20	60	300	200
NT 6040 / AG 6040 RR 10	60	400	100
NT 6040 / AG 6040 RR 20	60	400	200
NT 6040 / AG 6040 RR 30	60	400	300
AG 10020 RR	100	200	100
AG 10030 RR 10	100	300	100
AG 10030 RR 20	100	300	200
AG 10040 RR 10	100	400	100
AG 10040 RR 20	100	400	200
AG 10040 RR 30	100	400	300

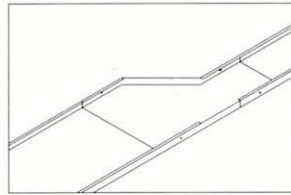
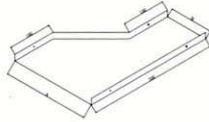

Değişik genişliğe sahip kablo kanalları arasında geçiş sağlar.

Supplies passing through various cable trays

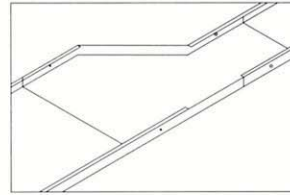

Gerekirse Sağa Redüksiyon elemanı M5 vida somun kullanarak birleştirilir.

It can be joint with M5 bolt whenever necessary

Sağa Redüksiyon Kanal Kapağı / Tray Cover
GT 200 RR K
GT 300 RR 10 K
GT 300 RR 20 K
GT 400 RR 10 K
GT 400 RR 20 K
GT 400 RR 30 K
NT 4020 / AK 40200 RR K
NT 4030 RR 10 K
NT 4030 RR 20 K
NT 4040 RR 10 K
NT 4040 RR 20 K
NT 4040 RR 30 K
NT 6020 / AG 6020 RR K
NT 6030 / AG 6030 RR 10 K
NT 6030 / AG 6030 RR 20 K
NT 6040 / AG 6040 RR 10 K
NT 6040 / AG 6040 RR 20 K
NT 6040 / AG 6040 RR 30 K
AG 10020 RR K
AG 10030 RR 10 K
AG 10030 RR 20 K
AG 10040 RR 10 K
AG 10040 RR 20 K
AG 10040 RR 30 K

Standart imalat malzemesi pregalvaniz sactır. / Standard production material is pregalvanized sheet.  
Boyalı ürünler için sipariş sonuna (B) harfi ekleyiniz. / For painted orders please add 'B' to the order no

\* / (ve) anlamında kullanılmıştır.

## BİRLEŞTİRME ELEMANLARI / JOINT ELEMENTS

### ORTADAN REDÜKSİYON / MID REDUCTION(OR)

Sipariş Kodu / Order No	H mm	A mm	B mm
GT 200 OR	15	200	100
GT 300 OR 10	15	300	100
GT 300 OR 20	15	300	200
GT 400 OR 10	15	400	100
GT 400 OR 20	15	400	200
GT 400 OR 30	15	400	300
NT 4020 / AK 40200 OR	40	200	100
NT 4030 OR 10	40	300	100
NT 4030 OR 20	40	300	200
NT 4040 OR 10	40	400	100
NT 4040 OR 20	40	400	200
NT 4040 OR 30	40	400	300
NT 6020 / AG 6020 OR	60	200	100
NT 6030 / AG 6030 OR 10	60	300	100
NT 6030 / AG 6030 OR 20	60	300	200
NT 6040 / AG 6040 OR 10	60	400	100
NT 6040 / AG 6040 OR 20	60	400	200
NT 6040 / AG 6040 OR 30	60	400	300
AG 10020 OR	100	200	100
AG 10030 OR 10	100	300	100
AG 10030 OR 20	100	300	200
AG 10040 OR 10	100	400	100
AG 10040 OR 20	100	400	200
AG 10040 OR 30	100	400	300

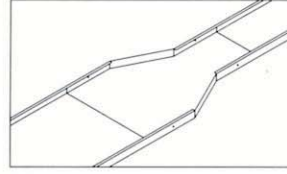
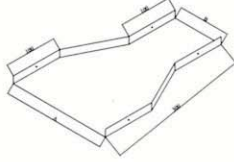

Değişik genişliğe sahip kablo kanalları arasında geçiş sağlar.

Supplies passing through various cable trays

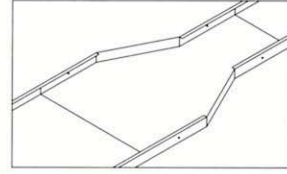

Gerekirse Ortadan Redüksiyon elemanı M5 vida somun kullanarak birleştirilir.

It can be joint with M5 bolt whenever necessary

Ortadan Redüksiyon Kanal Kapağı / Tray Cover
GT 200 OR K
GT 300 OR 10 K
GT 300 OR 20 K
GT 400 OR 10 K
GT 400 OR 20 K
GT 400 OR 30 K
NT 4020 / AK 40200 OR K
NT 4030 OR 10 K
NT 4030 OR 20 K
NT 4040 OR 10 K
NT 4040 OR 20 K
NT 4040 OR 30 K
NT 6020 / AG 6020 OR K
NT 6030 / AG 6030 OR 10 K
NT 6030 / AG 6030 OR 20 K
NT 6040 / AG 6040 OR 10 K
NT 6040 / AG 6040 OR 20 K
NT 6040 / AG 6040 OR 30 K
AG 10020 OR K
AG 10030 OR 10 K
AG 10030 OR 20 K
AG 10040 OR 10 K
AG 10040 OR 20 K
AG 10040 OR 30 K

### DÖRTLÜ BAĞLANTI / 4 JOINT (DB)

Sipariş Kodu / Order No	H mm	A mm
GT 50 DB	15	50
GT 100 DB	15	100
GT 150 DB	15	150
GT 200 DB	15	200
GT 250 DB	15	250
GT 300 DB	15	300
GT 400 DB	15	400
NT 4005 DB	40	50
AK 4070 DB	40	70
NT 4010 / AK 40100 DB	40	100
NT 4020 / AK 40200 DB	40	200
NT 4030 DB	40	300
NT 4040 DB	40	400
NT 4050 DB	40	500
NT 4060 DB	40	600
NT 6005 DB	60	50
NT 6010 / AG 6010 DB	60	100
NT 6020 / AG 6020 DB	60	200
NT 6030 / AG 6030 DB	60	300
NT 6040 / AG 6040 DB	60	400
NT 6050 / AG 6050 DB	60	500
NT 6060 / AG 6060 DB	60	600
AG 10010 DB	100	100
AG 10020 DB	100	200
AG 10030 DB	100	300
AG 10040 DB	100	400
AG 10050 DB	100	500
AG 10060 DB	100	600

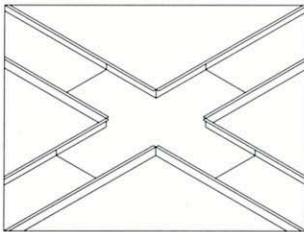
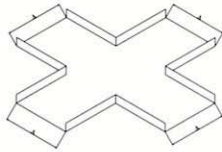

90 yatay X kavşak birleştirme amacıyla kullanılır.

Horizontal piece can be used with joining

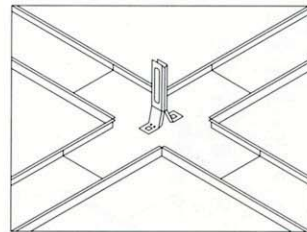

Gerekirse Dörtlü Bağlantı elemanı M5 vida somun kullanarak birleştirilir. A21 ve D73 askı elemanları tabandan delik delme sureti ile Dörtlü bağlantı elemanını askılamakta kullanılabilir.

It can be joint with M5 bolt whenever necessary

Dörtlü Bağlantı Kanal Kapağı / Tray Cover
GT 50 DB K
GT 100 DB K
GT 150 DB K
GT 200 DB K
GT 250 DB K
GT 300 DB K
GT 400 DB K
NT 4005 DB K
AK 4070 DB K
NT 4010 / AK 40100 DB K
NT 4020 / AK 40200 DB K
NT 4030 DB K
NT 4040 DB K
NT 4050 DB K
NT 4060 DB K
NT 6005 DB K
NT 6010 / AG 6010 DB K
NT 6020 / AG 6020 DB K
NT 6030 / AG 6030 DB K
NT 6040 / AG 6040 DB K
NT 6050 / AG 6050 DB K
NT 6060 / AG 6060 DB K
AG 10010 DB K
AG 10020 DB K
AG 10030 DB K
AG 10040 DB K
AG 10050 DB K
AG 10060 DB K

Standart imalat malzemesi pregalvaniz sactır. / Standard production material is pregalvanized sheet.  
Boyalı ürünler için sipariş sonuna (B) harfi ekleyiniz. / For painted orders please add 'B' to the order no

\* / (ve) anlamında kullanılmıştır.

## BİRLEŞTİRME ELEMANLARI / JOINT ELEMENTS

### DIŞ BÜKEY DÖNÜŞ / CONVEX TURN (DD)

Sipariş Kodu / Order No	H mm	A mm
GT 50 DD	15	50
GT 100 DD	15	100
GT 150 DD	15	150
GT 200 DD	15	200
GT 250 DD	15	250
GT 300 DD	15	300
GT 400 DD	15	400
NT 4005 DD	40	50
AK 4070 DD	40	70
NT 4010 / AK 40100 DD	40	100
NT 4020 / AK 40200 DD	40	200
NT 4030 DD	40	300
NT 4040 DD	40	400
NT 4050 DD	40	500
NT 4060 DD	40	600
NT 6005 DD	60	50
NT 6010 / AG 6010 DD	60	100
NT 6020 / AG 6020 DD	60	200
NT 6030 / AG 6030 DD	60	300
NT 6040 / AG 6040 DD	60	400
NT 6050 / AG 6050 DD	60	500
NT 6060 / AG 6060 DD	60	600
AG 10010 DD	100	100
AG 10020 DD	100	200
AG 10030DD	100	300
AG 10040 DD	100	400
AG 10050 DD	100	500
AG 10060 DD	100	600

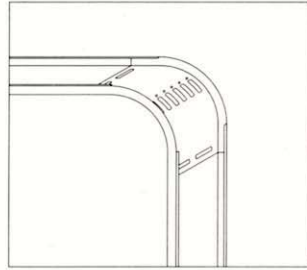
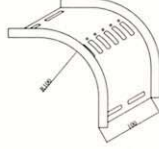

90 Dikey dönüş amacıyla kullanılır.  
Kablo kanallarının dışına M5 vida somun  
kullanılarak birleştirilir.

*It can be joint with M5 bolt whenever.*

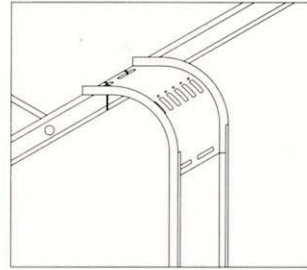

Kablo kanallarına kablo bağı ile  
birleştirilebilir.

*It can be joint with cable strip to the  
cable trays.*

Dış Bükey Dönüş Kanal Kapağı / Tray Cover
GT 50 DD K
GT 100 DD K
GT 150 DD K
GT 200 DD K
GT 250 DD K
GT 300 DD K
GT 400 DD K
NT 4005 DD K
AK 4070 DD K
NT 4010 / AK 40100 DD K
NT 4020 / AK 40200 DD K
NT 4030 DD K
NT 4040 DD K
NT 4050 DD K
NT 4060 DD K
NT 6005 DD K
NT 6010 / AG 6010 DD K
NT 6020 / AG 6020 DD K
NT 6030 / AG 6030 DD K
NT 6040 / AG 6040 DD K
NT 6050 / AG 6050 DD K
NT 6060 / AG 6060 DD K
AG 10010 DD K
AG 10020 DD K
AG 10030DD K
AG 10040 DD K
AG 10050 DD K
AG 10060 DD K

### İÇ BÜKEY DÖNÜŞ / CONCAVE TURN (İB)

Sipariş Kodu / Order No	H mm	A mm
GT 50 İB	15	50
GT 100 İB	15	100
GT 150 İB	15	150
GT 200 İB	15	200
GT 250 İB	15	250
GT 300 İB	15	300
GT 400 İB	15	400
NT 4005 İB	40	50
AK 4070 İB	40	70
NT 4010 / AK 40100 İB	40	100
NT 4020 / AK 40200 İB	40	200
NT 4030 İB	40	300
NT 4040 İB	40	400
NT 4050 İB	40	500
NT 4060 İB	40	600
NT 6005 İB	60	50
NT 6010 / AG 6010 İB	60	100
NT 6020 / AG 6020 İB	60	200
NT 6030 / AG 6030 İB	60	300
NT 6040 / AG 6040 İB	60	400
NT 6050 / AG 6050 İB	60	500
NT 6060 / AG 6060 İB	60	600
AG 10010 İB	100	100
AG 10020 İB	100	200
AG 10030İB	100	300
AG 10040 İB	100	400
AG 10050 İB	100	500
AG 10060 İB	100	600

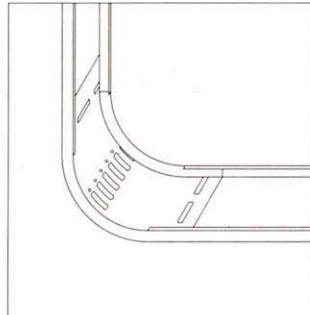
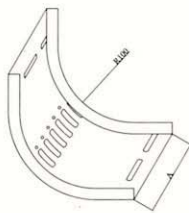

90 Dikey dönüş amacıyla kullanılır.  
Kablo kanallarının dışına M5 vida  
somun kullanılarak birleştirilir.

*It can be joint with M5 bolt whenever*

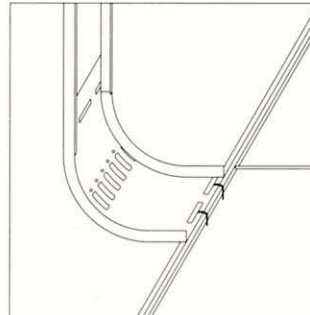

Kablo kanallarına kablo bağı ile  
birleştirilebilir.

*It can be joint with cable strip to  
the cable trays.*

İç Bükey Dönüş Kanal Kapağı / Tray Cover
GT 50 İB K
GT 100 İB K
GT 150 İB K
GT 200 İB K
GT 250 İB K
GT 300 İB K
GT 400 İB K
NT 4005 İB K
AK 4070 İB K
NT 4010 / AK 40100 İB K
NT 4020 / AK 40200 İB K
NT 4030 İB K
NT 4040 İB K
NT 4050 İB K
NT 4060 İB K
NT 6005 İB K
NT 6010 / AG 6010 İB K
NT 6020 / AG 6020 İB K
NT 6030 / AG 6030 İB K
NT 6040 / AG 6040 İB K
NT 6050 / AG 6050 İB K
NT 6060 / AG 6060 İB K
AG 10010 İB K
AG 10020 İB K
AG 10030İB K
AG 10040 İB K
AG 10050 İB K
AG 10060 İB K

Standart imalat malzemesi pregalvaniz sactır. / Standard production material is pregalvanized sheet.  
Boyalı ürünler için sipariş sonuna (B) harfi ekleyiniz. / For painted orders please add 'B' to the order no

\* / (ve) anlamında kullanılmıştır.



## BİRLEŞTİRME ELEMANLARI / JOINT ELEMENTS

### SEVİYE DEĞİŞTİRME / LEVEL CHANGER (SD)

Sipariş Kodu / Order No	H mm	A mm
GT 50 SD	15	50
GT 100 SD	15	100
GT 150 SD	15	150
GT 200 SD	15	200
GT 250 SD	15	250
GT 300 SD	15	300
GT 400 SD	15	400
NT 4005 SD	40	50
AK 4070 SD	40	70
NT 4010 / AK 40100 SD	40	100
NT 4020 / AK 40200 SD	40	200
NT 4030 SD	40	300
NT 4040 SD	40	400
NT 4050 SD	40	500
NT 4060 SD	40	600
NT 6005 SD	60	50
NT 6010 / AG 6010 SD	60	100
NT 6020 / AG 6020 SD	60	200
NT 6030 / AG 6030 SD	60	300
NT 6040 / AG 6040 SD	60	400
NT 6050 / AG 6050 SD	60	500
NT 6060 / AG 6060 SD	60	600
AG 10010 SD	100	100
AG 10020 SD	100	200
AG 10030 SD	100	300
AG 10040 SD	100	400
AG 10050 SD	100	500
AG 10060 SD	100	600

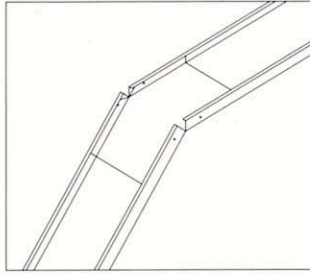
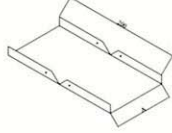

Aşağı veya yukarı yönde 90'ye kadar istenilen açıda seviye değiştirir.

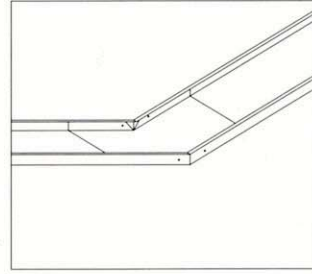

Gerekirse Seviye Değiştirme elemanı M5 vida somun kullanarak birleştirilir.

*It can be joint with M5 bolt whenever necessary*

### SONLANDIRMA KAPAĞI / END COVER (SK)

Sipariş Kodu / Order No	H mm	A mm
GT 50 SK	15	50
GT 100 SK	15	100
GT 150 SK	15	150
GT 200 SK	15	200
GT 250 SK	15	250
GT 300 SK	15	300
GT 400 SK	15	400
NT 4005 SK	40	50
AK 4070 SK	40	70
NT 4010 / AK 40100 SK	40	100
NT 4020 / AK 40200 SK	40	200
NT 4030 SK	40	300
NT 4040 SK	40	400
NT 4050 SK	40	500
NT 4060 SK	40	600
NT 6005 SK	60	50
NT 6010 / AG 6010 SK	60	100
NT 6020 / AG 6020 SK	60	200
NT 6030 / AG 6030 SK	60	300
NT 6040 / AG 6040 SK	60	400
NT 6050 / AG 6050 SK	60	500
NT 6060 / AG 6060 SK	60	600
AG 10010 SK	100	100
AG 10020 SK	100	200
AG 10030 SK	100	300
AG 10040 SK	100	400
AG 10050 SK	100	500
AG 10060 SK	100	600

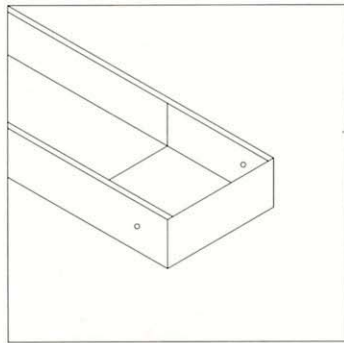
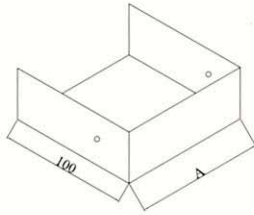

Kablo kanallarının sonlarına takılır.

*Mounted at the end of the tray*

Gerekirse Seviye Değiştirme elemanı M5 vida somun kullanarak birleştirilir.

*It can be joint with M5 bolt whenever necessary*

Standart imalat malzemesi pregalvaniz sactır. / Standard production material is pregalvanized sheet.  
Boyalı ürünler için sipariş sonuna (B) harfi ekleyiniz. / For painted orders please add 'B' to the order no

\* / (ve) anlamında kullanılmıştır.

## KABLO MERDİVENLERİ / CABLE LADDERS

Sipariş Kodu / Order No	H mm	A mm	t mm
KM 4010	40	100	1.5
KM 4020	40	200	1.5
KM 4030	40	300	1.5
KM 4040	40	400	1.5
KM 4050	40	500	1.5
KM 4060	40	600	1.5
KM 6010	60	100	1.5
KM 6020	60	200	1.5
KM 6030	60	300	1.5
KM 6040	60	400	1.5
KM 6050	60	500	1.5
KM 6060	60	600	1.5
KM 10010	100	100	1.5
KM 10020	100	200	1.5
KM 10030	100	300	1.5
KM 10040	100	400	1.5
KM 10050	100	500	1.5
KM 10060	100	600	1.5



## BİRLEŞTİRME ELEMANLARI / JOINT ELEMENTS

### 90 YATAY DÖNÜŞ / HORIZONTAL BEND

Sipariş Kodu / Order No	H mm	A mm	t mm
KM 4010 YD	40	100	1.5
KM 4020 YD	40	200	1.5
KM 4030 YD	40	300	1.5
KM 4040 YD	40	400	1.5
KM 4050 YD	40	500	1.5
KM 4060 YD	40	600	1.5
KM 6010 YD	60	100	1.5
KM 6020 YD	60	200	1.5
KM 6030 YD	60	300	1.5
KM 6040 YD	60	400	1.5
KM 6050 YD	60	500	1.5
KM 6060 YD	60	600	1.5
KM 10010 YD	100	100	1.5
KM 10020 YD	100	200	1.5
KM 10030 YD	100	300	1.5
KM 10040 YD	100	400	1.5
KM 10050 YD	100	500	1.5
KM 10060 YD	100	600	1.5

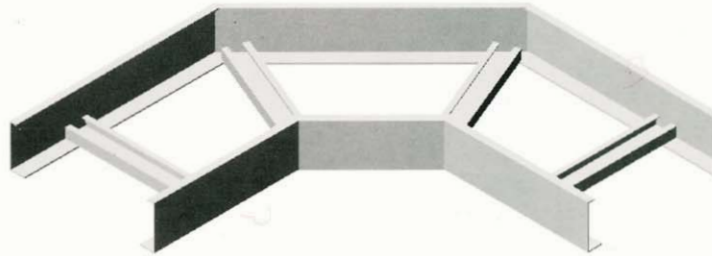

## BİRLEŞTİRME ELEMANLARI / JOINT ELEMENTS

### T DÖNÜŞ / T JUNCTION

Sipariş Kodu / Order No	H mm	A mm	t mm
KM 4010 TD	40	100	1.5
KM 4020 TD	40	200	1.5
KM 4030 TD	40	300	1.5
KM 4040 TD	40	400	1.5
KM 4050 TD	40	500	1.5
KM 4060 TD	40	600	1.5
KM 6010 TD	60	100	1.5
KM 6020 TD	60	200	1.5
KM 6030 TD	60	300	1.5
KM 6040 TD	60	400	1.5
KM 6050 TD	60	500	1.5
KM 6060 TD	60	600	1.5
KM 10010 TD	100	100	1.5
KM 10020 TD	100	200	1.5
KM 10030 TD	100	300	1.5
KM 10040 TD	100	400	1.5
KM 10050 TD	100	500	1.5
KM 10060 TD	100	600	1.5

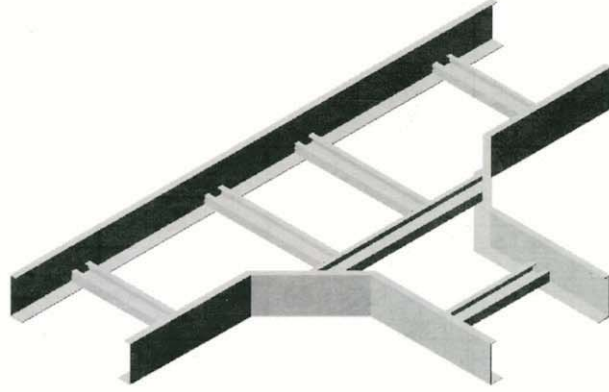

### DÖRTLÜ BAĞLANTI / 4 JOINT

Sipariş Kodu / Order No	H mm	A mm	t mm
KM 4010 DB	40	100	1.5
KM 4020 DB	40	200	1.5
KM 4030 DB	40	300	1.5
KM 4040 DB	40	400	1.5
KM 4050 DB	40	500	1.5
KM 4060 DB	40	600	1.5
KM 6010 DB	60	100	1.5
KM 6020 DB	60	200	1.5
KM 6030 DB	60	300	1.5
KM 6040 DB	60	400	1.5
KM 6050 DB	60	500	1.5
KM 6060 DB	60	600	1.5
KM 10010 DB	100	100	1.5
KM 10020 DB	100	200	1.5
KM 10030 DB	100	300	1.5
KM 10040 DB	100	400	1.5
KM 10050 DB	100	500	1.5
KM 10060 DB	100	600	1.5

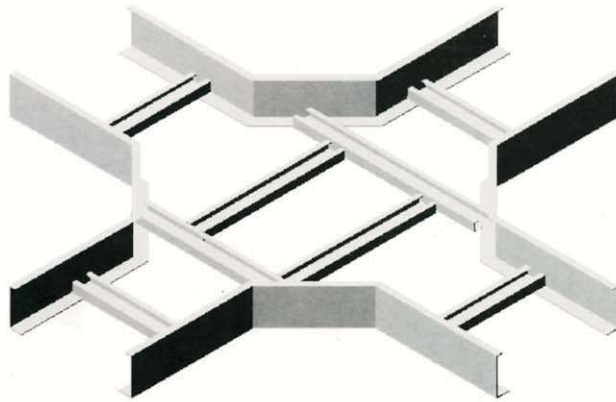

## BİRLEŞTİRME ELEMANLARI / JOINT ELEMENTS

### İÇ BÜKEY DÖNÜŞ / CONCAVE BEND

Sipariş Kodu / Order No	H mm	A mm	t mm
KM 4010 İB	40	100	1.5
KM 4020 İB	40	200	1.5
KM 4030 İB	40	300	1.5
KM 4040 İB	40	400	1.5
KM 4050 İB	40	500	1.5
KM 4060 İB	40	600	1.5
KM 6010 İB	60	100	1.5
KM 6020 İB	60	200	1.5
KM 6030 İB	60	300	1.5
KM 6040 İB	60	400	1.5
KM 6050 İB	60	500	1.5
KM 6060 İB	60	600	1.5
KM 10010 İB	100	100	1.5
KM 10020 İB	100	200	1.5
KM 10030 İB	100	300	1.5
KM 10040 İB	100	400	1.5
KM 10050 İB	100	500	1.5
KM 10060 İB	100	600	1.5



### DIŞ BÜKEY DÖNÜŞ / CONVEX BEND

Sipariş Kodu / Order No	H mm	A mm	t mm
KM 4010 DD	40	100	1.5
KM 4020 DD	40	200	1.5
KM 4030 DD	40	300	1.5
KM 4040 DD	40	400	1.5
KM 4050 DD	40	500	1.5
KM 4060 DD	40	600	1.5
KM 6010 DD	60	100	1.5
KM 6020 DD	60	200	1.5
KM 6030 DD	60	300	1.5
KM 6040 DD	60	400	1.5
KM 6050 DD	60	500	1.5
KM 6060 DD	60	600	1.5
KM 10010 DD	100	100	1.5
KM 10020 DD	100	200	1.5
KM 10030 DD	100	300	1.5
KM 10040 DD	100	400	1.5
KM 10050 DD	100	500	1.5
KM 10060 DD	100	600	1.5



## AĞ TİP KABLO KANALLARI / MESH TYPE CABLE TRAYS

Sipariş Kodu / Order No	H mm	A mm	Tel Çapı / Wire Dia.mm
AT 40504	40	50	4
AT 40505	40	50	5
AT 60105	60	100	5
AT 60305	60	300	5
AT 60405	60	400	5



## BAĞLAMA ELEMANLARI / JOINT ELEMENTS

### EK ELEMANI B1 / ADD IN ELEMENT B1

Sipariş Kodu / Order No	B1
-------------------------	----

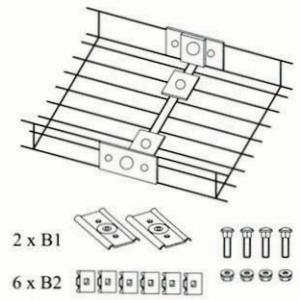
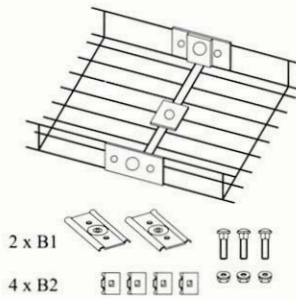
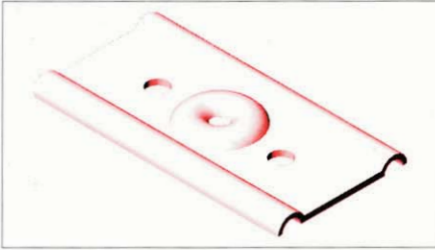

### EK ELEMANI B2 / ADD IN ELEMENT B2

Sipariş Kodu / Order No	B2
-------------------------	----

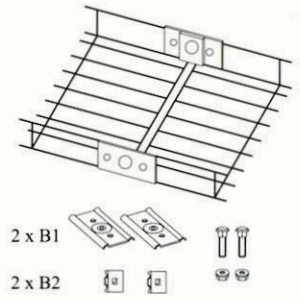
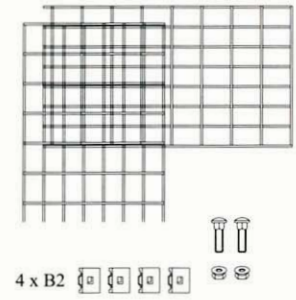
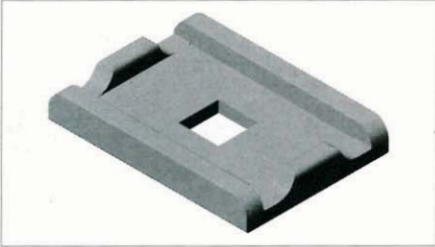

### EK ELEMANI B3 / ADD IN ELEMENT B3

Sipariş Kodu / Order No	B3
-------------------------	----

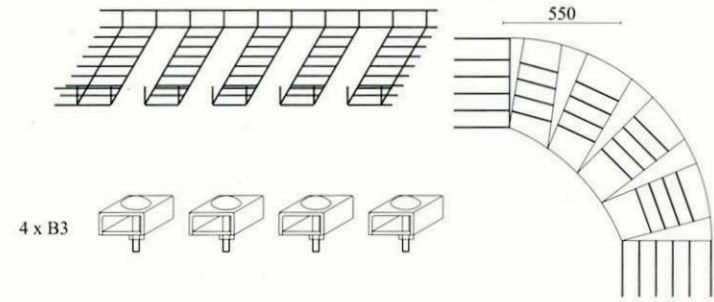
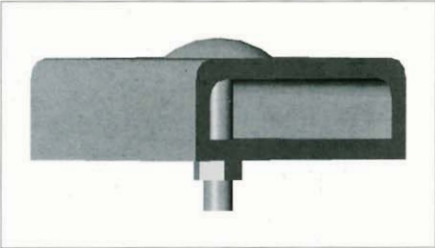

### EK ELEMANI B27 / ADD IN ELEMENT B27

Sipariş Kodu / Order No	B27
-------------------------	-----

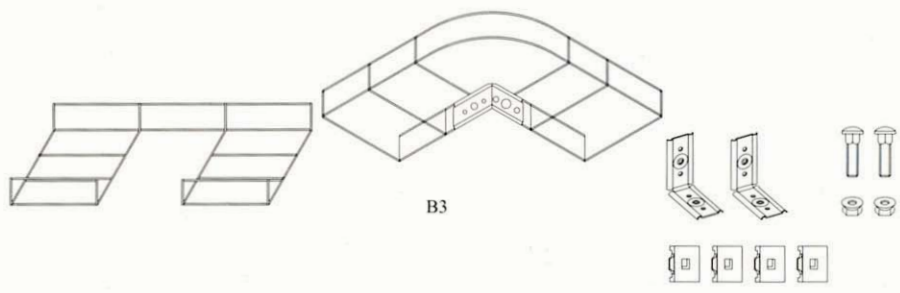

## BAĞLAMA ELEMANLARI / JOINT ELEMENTS

### EK ELEMANI / ADD IN ELEMENT

Ek elemanı iki kablo kanalını yanal yüzeylerinden birbirine eklemek amacıyla M6 vida ve somun ile birlikte kullanılır.  
This is used for joining two trays from their sides.

Sipariş Kodu / Order No	H mm
EK 15	15
EK 40	40
EK 60	60
EK 100	100

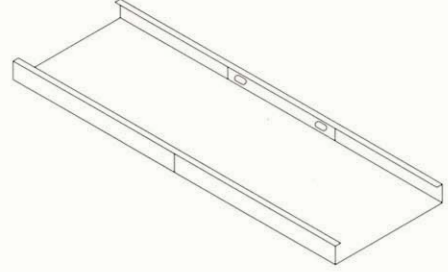
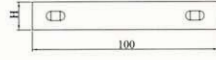

### SEPERATÖR / SEPERATOR

Kablo kanallarını birden fazla bölmeye ayırmak için kullanılır. Böylelikle birbirlerinden farklı kablolar birbirlerine karışmazlar.  
It is used for dividing the tray more than one pieces. So that the cables can not be able to mix up.

Sipariş Kodu / Order No	H mm
S 15	15
S 40	40
S 60	60
S 100	100

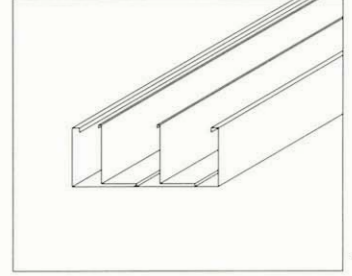
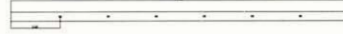
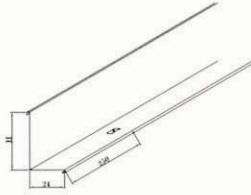

### BAĞLANTI KUTU PLEYTİ / JOINT BOX PLATE

Bağlantı kutu pleyti, kablo kanallarına kutuların, aydınlatma ekipmanlarının vb. aksesuarların bağlanması için kullanılır. Bağlantı kutu pleyti kablo kanalına taban ve büküm kenarları arasına sıkıştırılarak veya kanal ortasına M5 vida somun kullanılarak damontaj edilebilir.  
This element is used for mounting the lighting equipments to the cable trays. This can be used with sticking it on the tray

Sipariş Kodu / Order No	H mm
BT 15	15
BT 40	40
BT 60	60
BT 100	100

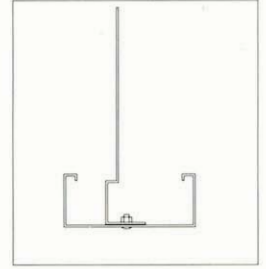
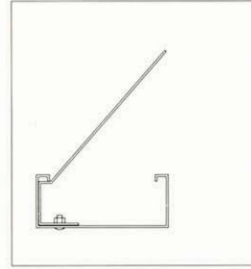
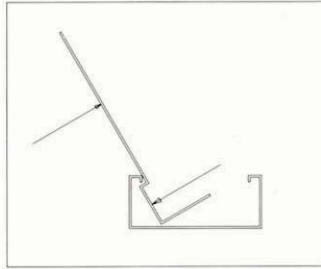
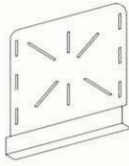

### ÇİFTLİ SOKET VE BAĞLANTI KUTU PLEYTİ / TWO SOCKETS & JOINT BOX PLATE

Bağlantı kutu pleytine çiftli priz soketi montaj edilmiş olarak kullanılan bir aksesuardır.  
Mounted on a joint box plate with a plug.

Sipariş Kodu / Order No	H mm
BTÇ 15	15
BTÇ 40	40
BTÇ 60	60
BTÇ 100	100

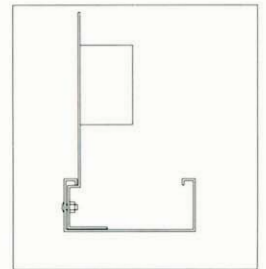
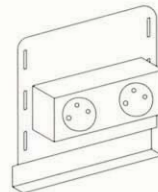

Standart imalat malzemesi pregalvaniz sactır. / Standard production material is pregalvanized sheet.  
Boyalı ürünler için sipariş sonuna (B) harfi ekleyiniz. / For painted orders please add 'B' to the order no

\* / (ve) anlamında kullanılmıştır.

## ASKI SİSTEMLERİ VE DUVAR KONSOLLARI / PENDANT SYSTEMS AND WALL CONSOLES

### KANAL TAŞIYICILAR

#### DAHİLİ DİRSEK KOLU / INTERNAL CANTILEVER ARM (D17)

Sipariş Kodu / Order No	A mm	B mm
D17-50	39	70
D17-70	59	70
D17-100	89	70
D17-150	139	70
D17-200	189	70
D17-250	239	70
D17-300	289	95
D17-400	389	95
D17-500	489	95
D17-600	589	95

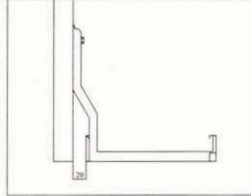
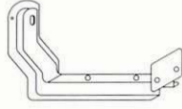

Dahili Dirsek Kolu D17 Dik Parça 2F üzerine monte edilebilir.

*Can be mounted on a vertical piece.*

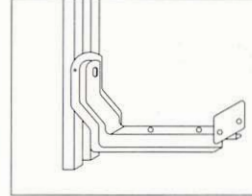

D 17 yüzey basıncı düşük olması gerektiğinde veya duvara montaj edilmesi gereken durumlarda Montaj Rayı T 40 ile kullanılmalıdır.

*It should be used with mounting rail T40 whenever the pressure should be low.*

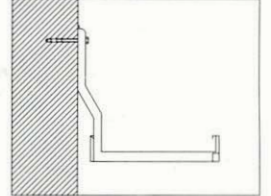

D 17 beton duvara çelik dübel ile monte edilebilir.

*Can be mounted on the wall.*

#### TAVAN ASKI AKSESUARI / CEILING PENDANT ACCESSORY (D 73)

Sipariş Kodu / Order No
D73

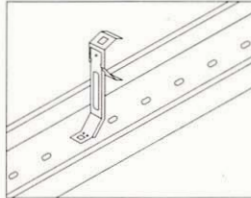

Tavan Askı Aksesuarı D73 M6 vida ve somun kullanılarak kablo kanallarında kullanılabilir.

*This item can be used with a nut on the trays.*

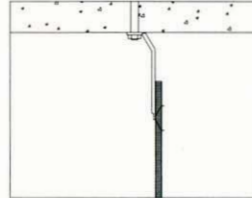

Askı Civatası T 76 ve çelik dübel kullanılarak kablo kanalı asılabilir.

*Can be used with pendant nut.*

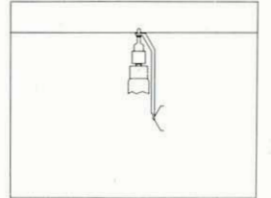

Ahşap yüzeylere ahşap vidası ile montaj edilebilir.

*Can be mounted on a wooden surface.*

#### UZATMA PROFİLİ / LENGHTING PROFILE (D 33)

Sipariş Kodu / Order No
D33

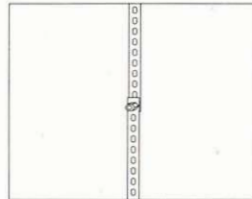

Uzatma profili düz imal edilir. İstendiğinde ucundan bükülür. 1 m'den uzun olması istendiğinde M5 vida ile birleştirilir.

*Lengthing profile is produced smoothly. Can be bended whenever necessary*

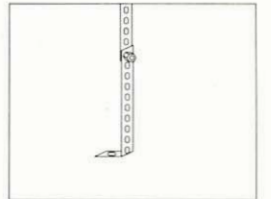

İstenilen herhangi bir boyaya ulaşabilmek için D 33 kesilerek birbirine eklenebilir.

*For having a sufficient length it can be cut.*

#### AÇI BRAKETİ / ANGLE BRACKET (D8)

Sipariş Kodu / Order No
D33

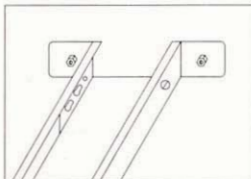

2 adet Açı Braketi D8 kullanarak kablo kanalını duvara veya zemine montaj edebilirsiniz.

*You can use Angle Bracket for mounting on the walls.*

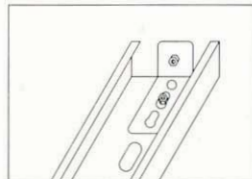

D 8'i Çelik Dübel ve M5 vida somun ile kullanarak kablo kanalını beton duvara montaj edebilirsiniz.

*Can be mounted to the walls.*

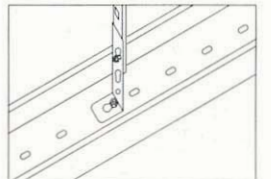

M5 vida somun kullanarak kablo kanalını asabilirsiniz.

*You can hang the tray by using this item.*

## ASKI SİSTEMLERİ VE DUVAR KONSOLLARI / PENDANT SYSTEMS AND WALL CONSOLES

### DUVAR KONSOLLARI / WALL CONSOLES

#### DİRSEK KOLU A112 (H 50)

Sipariş Kodu / Order No	A mm	H mm
H50-50	100	85
H50-70	120	85
H50-100	150	85
H50-150	200	85
H50-200	250	105
H50-250	300	105
H50-300	350	120
H50-400	450	120
H50-500	550	140
H50-600	650	160

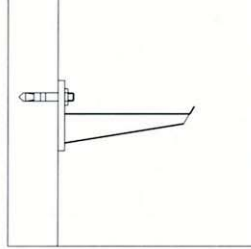
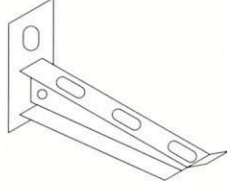

Çelik dübel kullanarak Dirsek Kolu H 50 beton duvara monte edilebilir.  
Can be mounted to the wall.

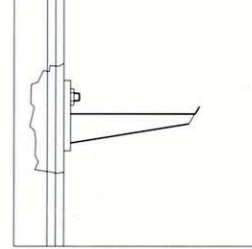

Duvara monte edilmiş T 32 Askı Rayı üzerine T somun kullanarak H 50 montaj edilebilir.  
Can be mounted to the pendant rail.

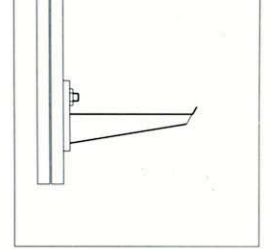

T somun kullanarak H 50'yi dikey aksesuarlar üzerine montaj edebilirsiniz.  
Can be mounted with a T nut.

#### DİRSEK KOLU / CANTİLEVER ARM (H 70)

Sipariş Kodu / Order No	A mm
H70-50	98
H70-70	118
H70-100	148
H70-150	198
H70-200	248
H70-250	298
H70-300	348
H70-400	448
H70-500	548
H70-600	648

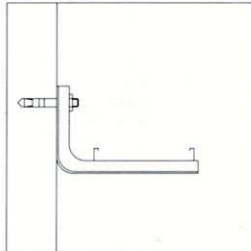
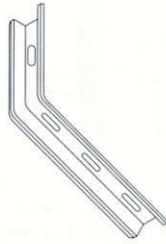

Çelik dübel kullanarak Dirsek Kolu H 50 beton duvara monte edilebilir.  
Can be mounted to the wall.

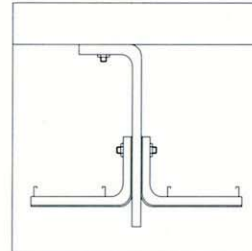

Duvara monte edilmiş T 32 Askı Rayı üzerine T somun kullanarak H 50 montaj edilebilir.  
Can be mounted to the pendant rail.

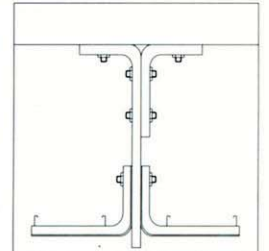

T somun kullanarak H 50'yi dikey aksesuarlar üzerine montaj edebilirsiniz.  
Can be mounted with a T nut.

#### ASKI UCU / PENDANT END (A 21)

Sipariş Kodu / Order No
A21

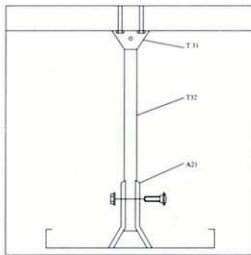
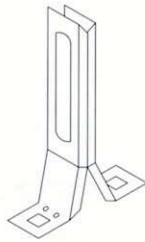

Kablo kanalını askılamak için A 21 , T 31 ve T 32 ile birlikte kullanılır.  
For hanging cable trays.

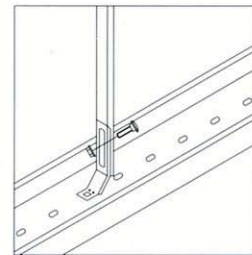

A 21 çiftli kullanılabildiği gibi tekli kullanılarak da kablo kanalı askılanabilir.  
Can be used both even or odd.

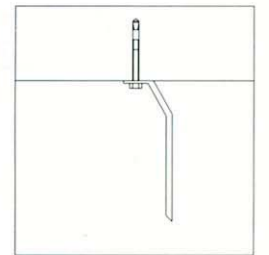

A 21 çelik dübel kullanılarak beton duvara montaj edilebilir.  
Can be mounted on the wall.

#### DESTEK BRAKETİ (A 1940)

Sipariş Kodu / Order No	A mm
A1940-50	50
A1940-70	70
A1940-100	100
A1940-150	150
A1940-200	200
A1940-250	250
A1940-300	300
A1940-400	400
A1940-500	500
A1940-600	600

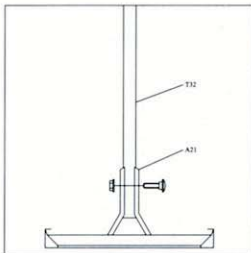
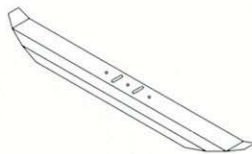

Kablo kanalları destek braketi A 1940, T 32 ve A 21 kullanarak askılanabilir.  
Used in hanging cable trays.

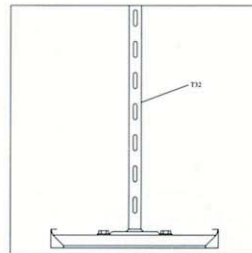

A 1940, T 76 Tij ile birlikte kullanılarak da kablo kanalı askılanabilir.  
Can be used in with a Teege.

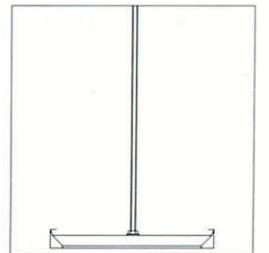

A 1940, T 2 birlikte kullanılarak da kablo kanalı askılanabilir.  
Can be used with T 2.



## ASKI SİSTEMLERİ VE DUVAR KONSOLLARI / PENDANT SYSTEMS AND WALL CONSOLES

### DUVAR KONSOLLARI / WALL CONSOLES

#### ASKI BARASI / PENDANT BARS (A 1)

Sipariş Kodu / Order No	A mm	H mm
A1-300	80	300
A1-500	130	500
A1-800	215	800
A1-100	280	1000

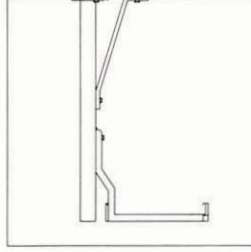

Ağır yüklerde T 2 üzerindeki  
sehimi azaltmak A 1 Askı Barası  
kullanılır.  
*It is used in heavy duty trays.*

#### MONTAJ RAYI / MOUNTING RAILS (T 40)

Sipariş Kodu / Order No
T40

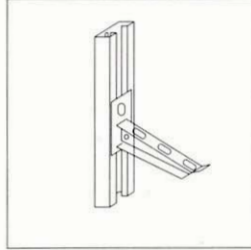

Montaj Rayı T 40, dirsek kolu  
H 50 ve H 70 ile tuğla duvar  
arasında kullanılarak duvardaki  
basıncı azaltır. Ayrıca dirsek  
kolunun dikeyde hareketini  
sağlar.  
*This piece is used for reducing  
pressure on the walls.*

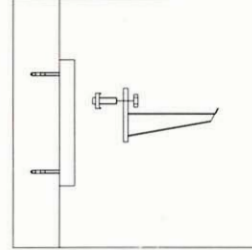

Dirsek kolları T 40 üzerinde  
T somun ile birlikte yüksekliği  
ayarlanabilir.  
*Cantilever arm is used with T  
bolt for adjusting the height.*

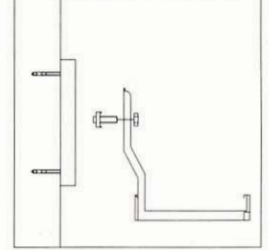

Dahili Dirsek Kolu D 17 ,  
T somun kullanılarak Montaj  
Rayı T 40 üzerine monte  
edilebilir.  
*D17 can be mounted on a  
mounting rail by using T bolt.*

#### TAVAN BAĞLANTISI / CEILING JOINT (T 31)

Sipariş Kodu / Order No
T31

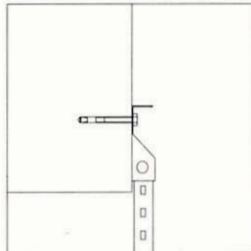
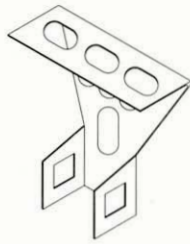

Tavan bağlantısı T 31 beton  
duvara çelik dübel ile monte  
edilir.

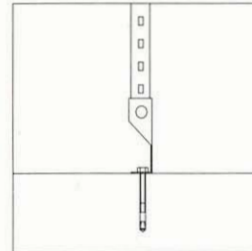

Tavan bağlantısı T 31 beton  
duvara çelik dübel ile monte  
edilir.

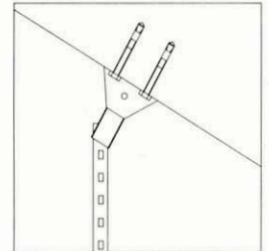

T 31 Eğik tavanlara da monte  
edilerek kablo kanalının  
düzlemselliğini sağlayabilir.

#### ASKI RAYI / PENDANT RAIL (T 32)

Sipariş Kodu / Order No
T32

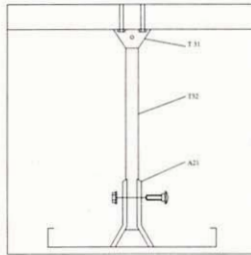

Askı rayı T 32, T 31 ve A 21  
ile birlikte kullanarak kablo  
kanalını askılayabilirsiniz.

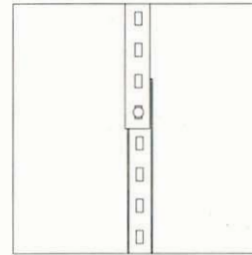

T 32 M6 vida somun kullanılarak  
birbirine eklenebilir.

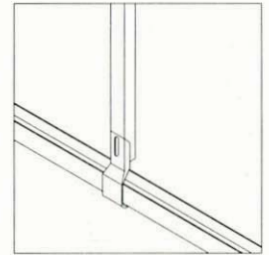

Aydınlatma kanalı Askı  
Braketi T 81 ve T 32 kullanarak  
askılabılır.

## ASKI SİSTEMLERİ VE DUVAR KONSOLLARI / PENDANT SYSTEMS AND WALL CONSOLES

### DUVAR KONSOLLARI / WALL CONSOLES

#### DİK PARÇA / VERTICAL PIECE (T 2)

Sipariş Kodu / Order No	L mm
T2-280	280
T2-370	370
T2-505	505
T2-730	730
T2-1000	1000

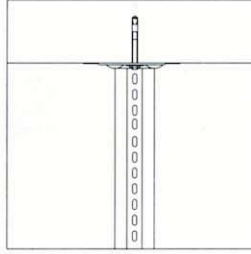
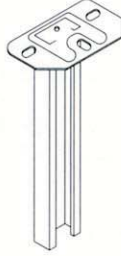

Dik Parça T 2 beton duvara çelik dübel ile montaj edilebilir.

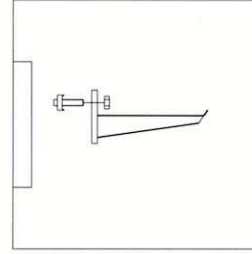

Dirsek Kolu H 50 ve H 70 T somun ile T 2'ye monte edilebilir.

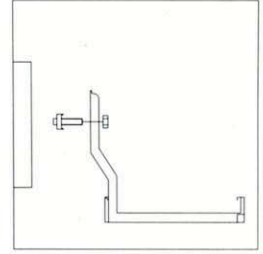

Dahili Dirsek Kolu D 17, T somun ile T 2'ye monte edilebilir.

#### M10 TİJ / TEEGE (T 76)

Sipariş Kodu / Order No	L mm
T76-2000	2000
T76-3000	3000

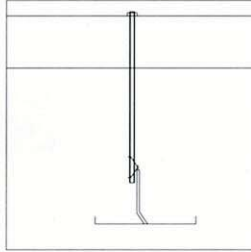

İnce duvarlara boyunca delik delinerek Tij T76 pul ve somun kullanılarak monte edilebilir.  
*Used in mounting throughout the thin walls.*

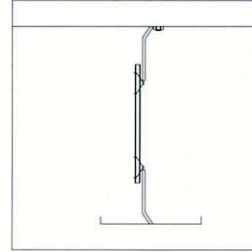

Tij T 76 uygun boyda kesilerek iki adet T 81 ile birlikte kablo kanalı montajında kullanılabilir.  
*Can be cut into pieces whenever necessary.*

#### ASKI BRAKETİ / PENDANT BRACKET (T 81)

Sipariş Kodu / Order No
T81

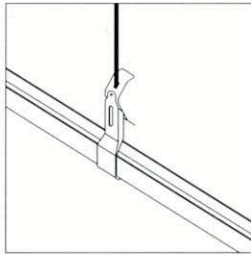
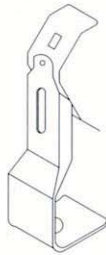

Aydınlatma kanallarının askılanmasında vidasız birleştirme olarak kullanılır.  
*Can be used in mounting lighting trunking pendant.*

#### DESTEK BRAKETİ / SUPPORT BRACKET (T 20)

Sipariş Kodu / Order No	A mm
T20-50	50
T20-70	70
T20-100	100
T20-150	150
T20-200	200
T20-250	250
T20-300	300
T20-400	400
T20-500	500
T20-600	600

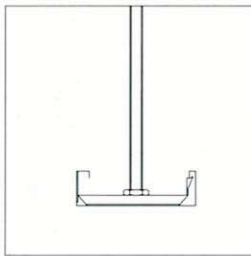
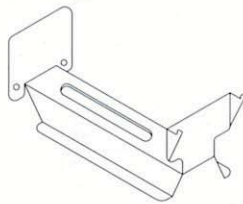

Aydınlatma kanallarının askılanmasında vidasız birleştirme olarak kullanılır.  
*Can be used in mounting lighting trunking pendant.*

## ASKI SİSTEMLERİ VE DUVAR KONSOLLARI / PENDANT SYSTEMS AND WALL CONSOLES

### DUVAR KONSOLLARI / WALL CONSOLES

#### ASKI DESTEĞİ / PENDANT SUPPORT (A 80)

Sipariş Kodu / Order No	A mm
A80-50	50
A80-70	70
A80-100	100
A80-150	150
A80-200	200
A80-250	250
A80-300	300
A80-400	400
A80-500	500
A80-600	600

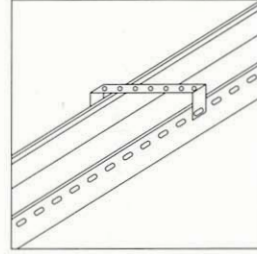
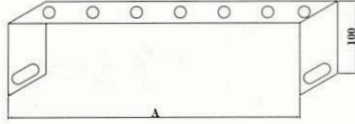

Kablo kanalını Askı Desteği A 80 ve Açık Braketi D 8 kullanarak askı ya alabilirsiniz.  
You can hang the cable tray with a pendant support.

#### DUVARA MONTAJLI YÜK TAŞIMA DIŞ YÜZEY KOLU / WALL MOUNTED LOAD CARRIER EXTERNAL SURFACE ARM

Dış Yüze Kolu Tipi	Dirsek kolunun 3° lik eğimindeki max. Yük		Dirsek kolunun 3° lik eğimindeki Yük		Yük Taşıma Kg
	Kn	Kg	Kn	Kg	
70-100	1,8	180	1,8	180	360
70-200	1,2	120	1,2	120	240
70-300	1,0	100	1,0	100	200
70-500	0,7	70	0,7	70	140
70-600	0,45	45	0,45	45	90

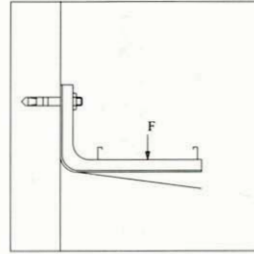

#### YÜK TAŞIMA F / LOAD CARRYING

Kol Çeşitleri / Type	Duvara montajlı / Wall mounted		26 F T civata ile raya montajlı / Mounted in a rail with 26 F	
	Kn	Kg	Kn	Kg
50/100	3,0	300	3,0	300
50/150	3,0	300	3,0	300
50/200	2,5	250	2,5	250
50/250	4,0	400	4,0	400
50/300	3,0	300	3,0	300
50/400	7,0	700	7,0	700
50/500	7,0	700	7,0	700
50/600	7,0	700	7,0	700

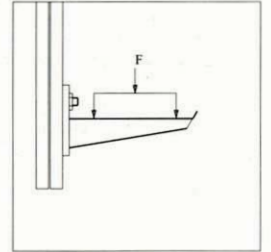
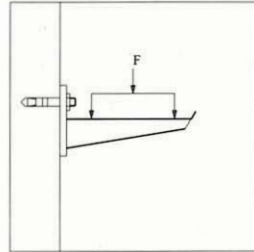

#### YÜK TAŞIMA F / LOAD CARRYING

	Dirsek Kolu Tipi / Type	2F/280		2F/370		2F/505		2F/730		2F/1000	
		Kn	Kg	Kn	Kg	Kn	Kg	Kn	Kg	Kn	Kg
Barsız / Without Bar	D17/100	0,65	65	0,65	65	0,65	65	0,55	55	0,55	55
	D17/200	0,60	60	0,60	60	0,50	50	0,50	50	0,45	45
	D17/300	0,70	70	0,70	70	0,70	70	0,65	65	0,55	55
	D17/400	0,55	55	0,55	55	0,55	55	0,50	50	0,45	45
Barlı 1/300 / With Bar	D17/100					0,75	75	0,70	70	0,65	65
	D17/200					0,60	60	0,55	55	0,50	50
	D17/300					0,80	80	0,75	75	0,70	70
	D17/400					0,70	70	0,65	65	0,50	50
Barlı 1/500	D17/100							0,90	90	0,70	70
	D17/200							0,70	70	0,60	60
	D17/300							0,95	95	0,80	80
	D17/400							0,70	70	0,55	55
Barlı 1/800	D17/100									0,80	80
	D17/200									0,60	60
	D17/300									0,85	85
	D17/400									0,65	65

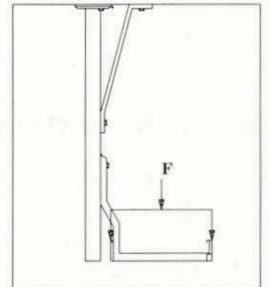

www.dtm-enclosures.com



Elektroteknik A.Ş.

Çatalmeşe Mah. Sultansuyu Cad. No:119  
34794 Alemdar / İSTANBUL / TÜRKİYE  
Tel: +90 216 429 5174 Fax: +90 216 429 4788  
email: info@dtm-enclosures.com